

# ASMA TAVAN SUSPENDING CEILING

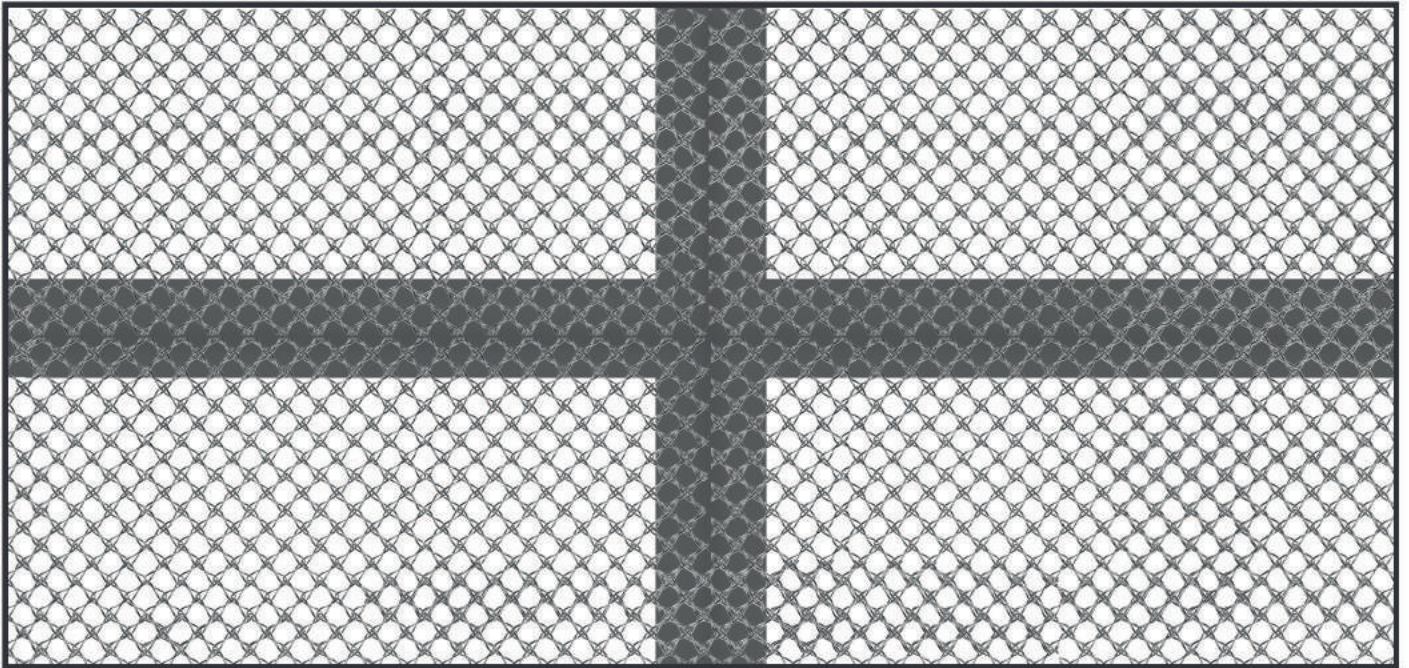

PANEL VIEW SCHEMA  
PANEL GÖRÜNÜM ŞEMASI

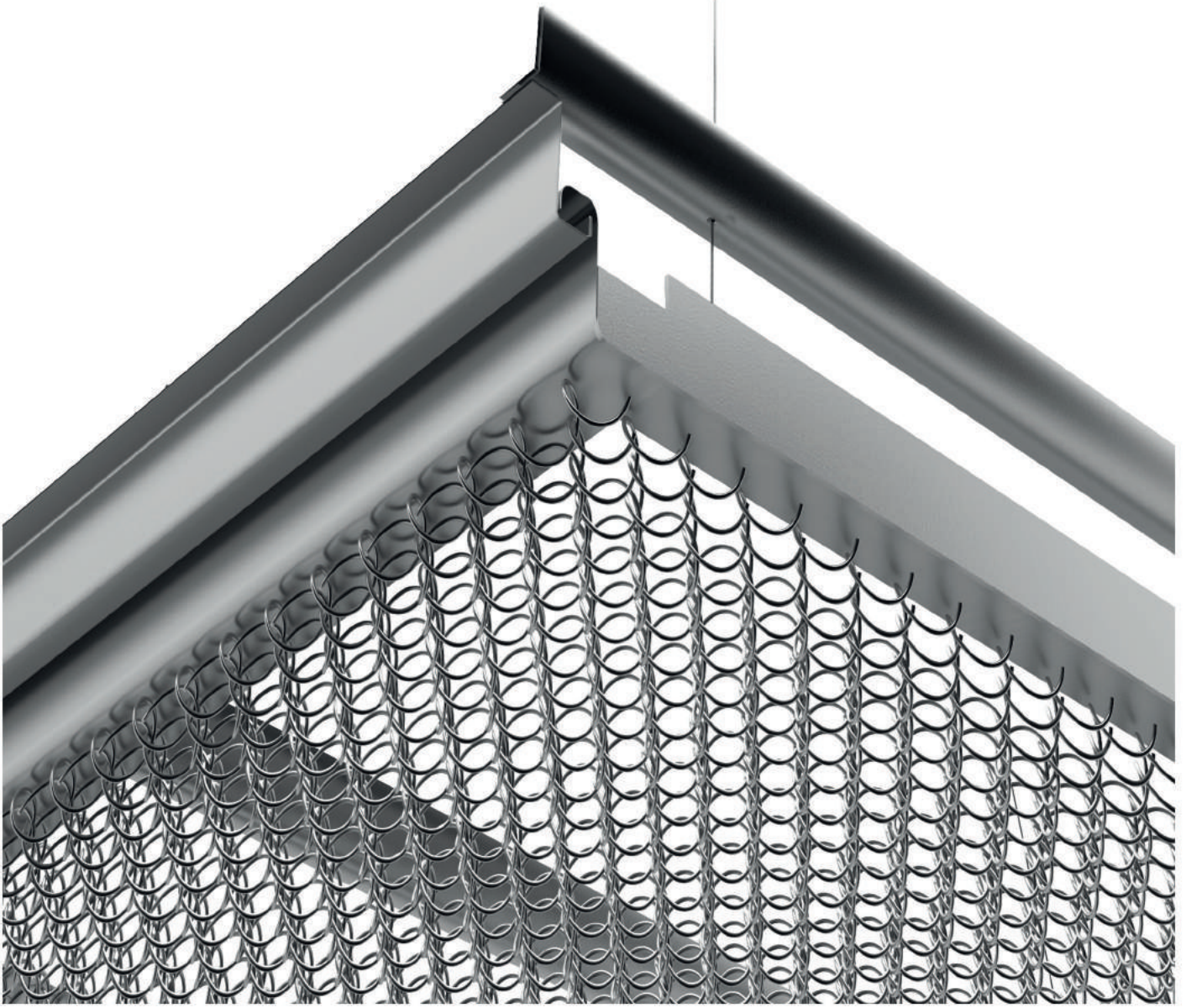
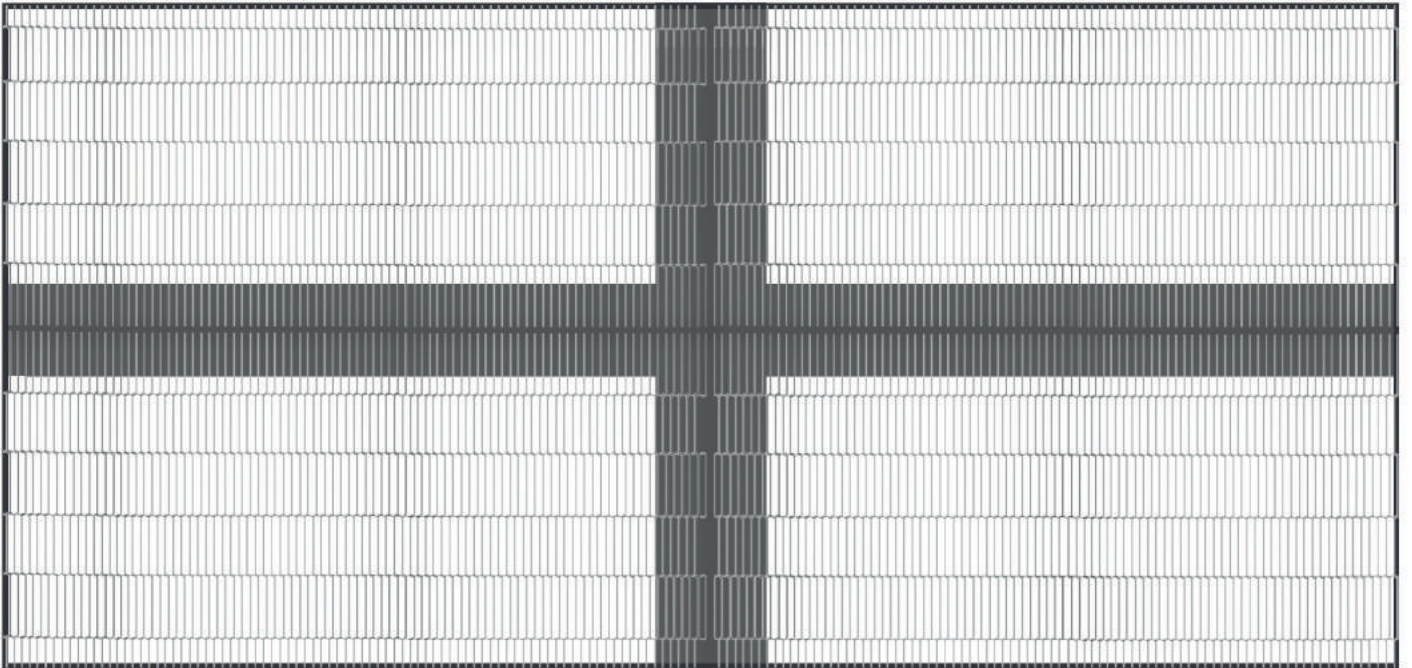
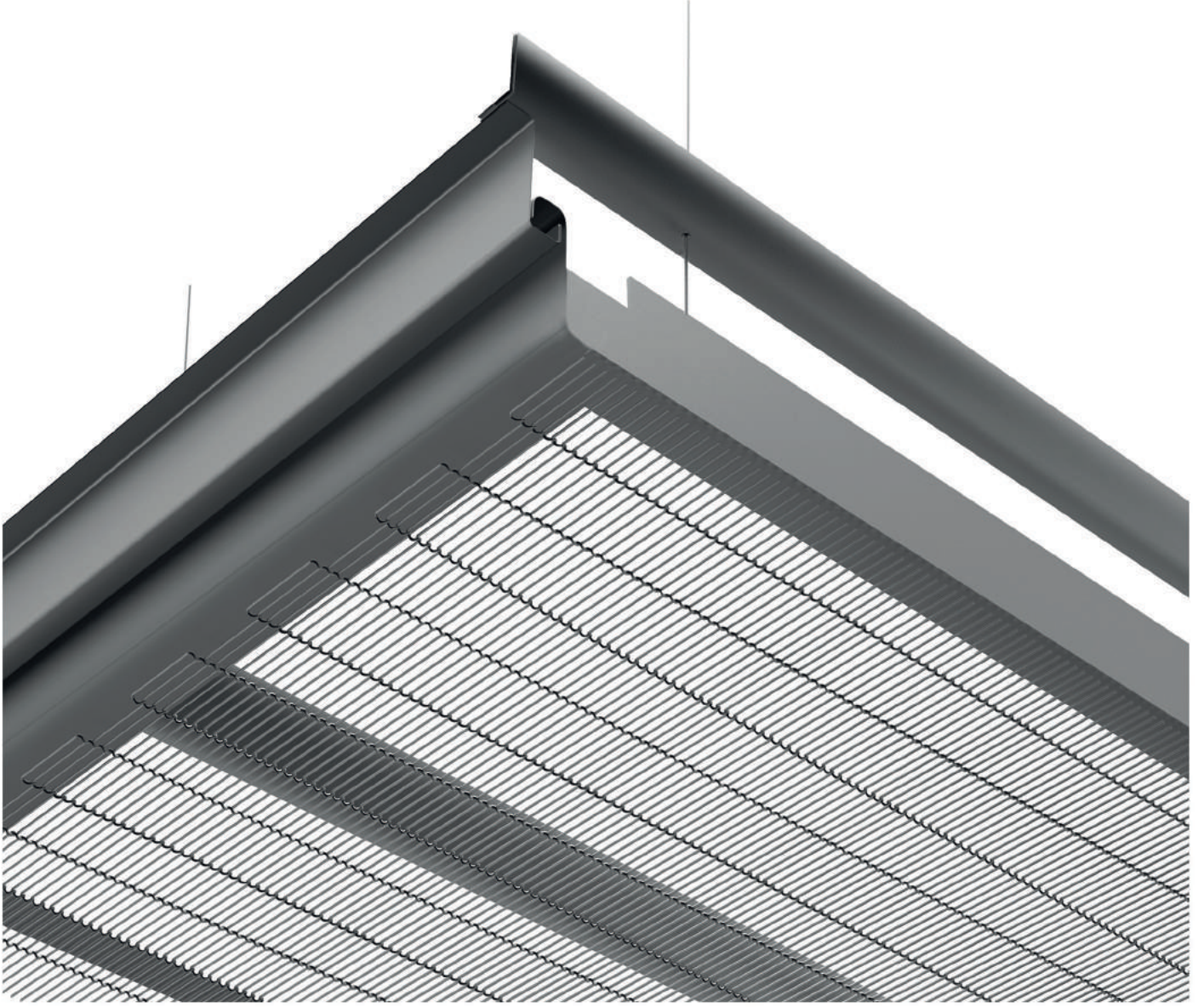

PANEL VIEW SCHEMA  
PANEL GÖRÜNÜM ŞEMASI

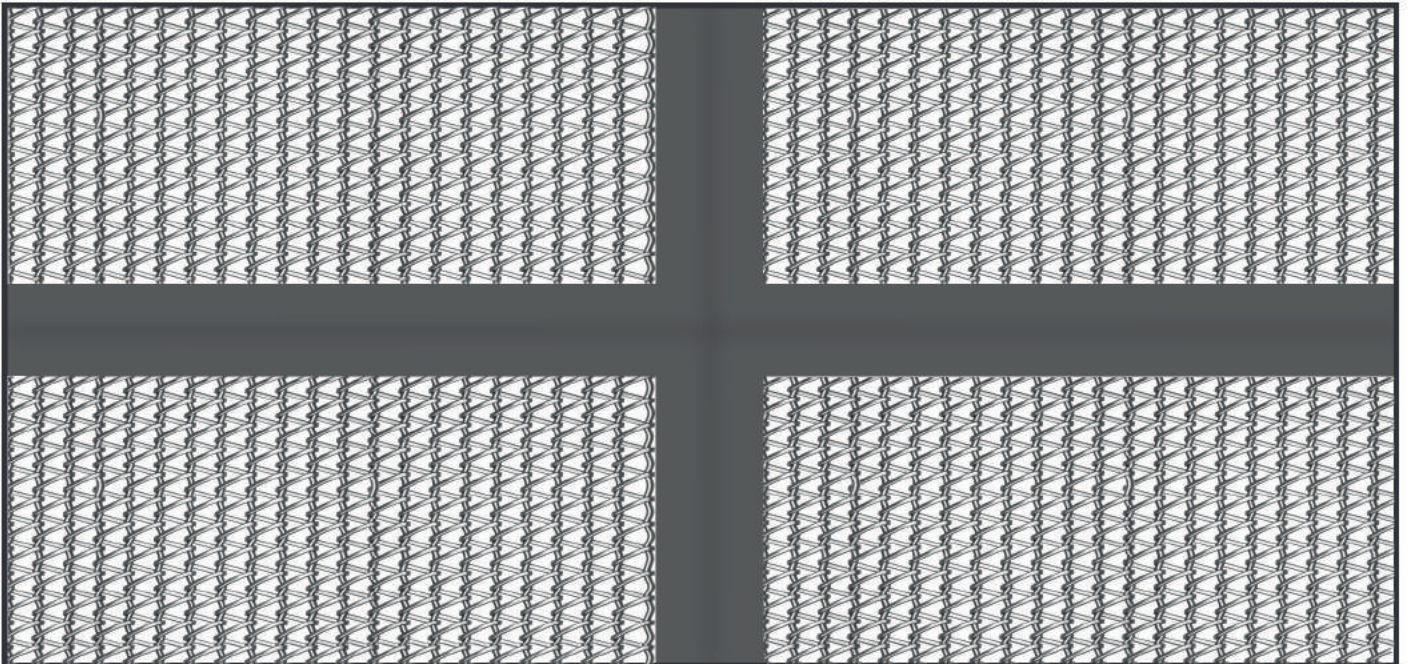
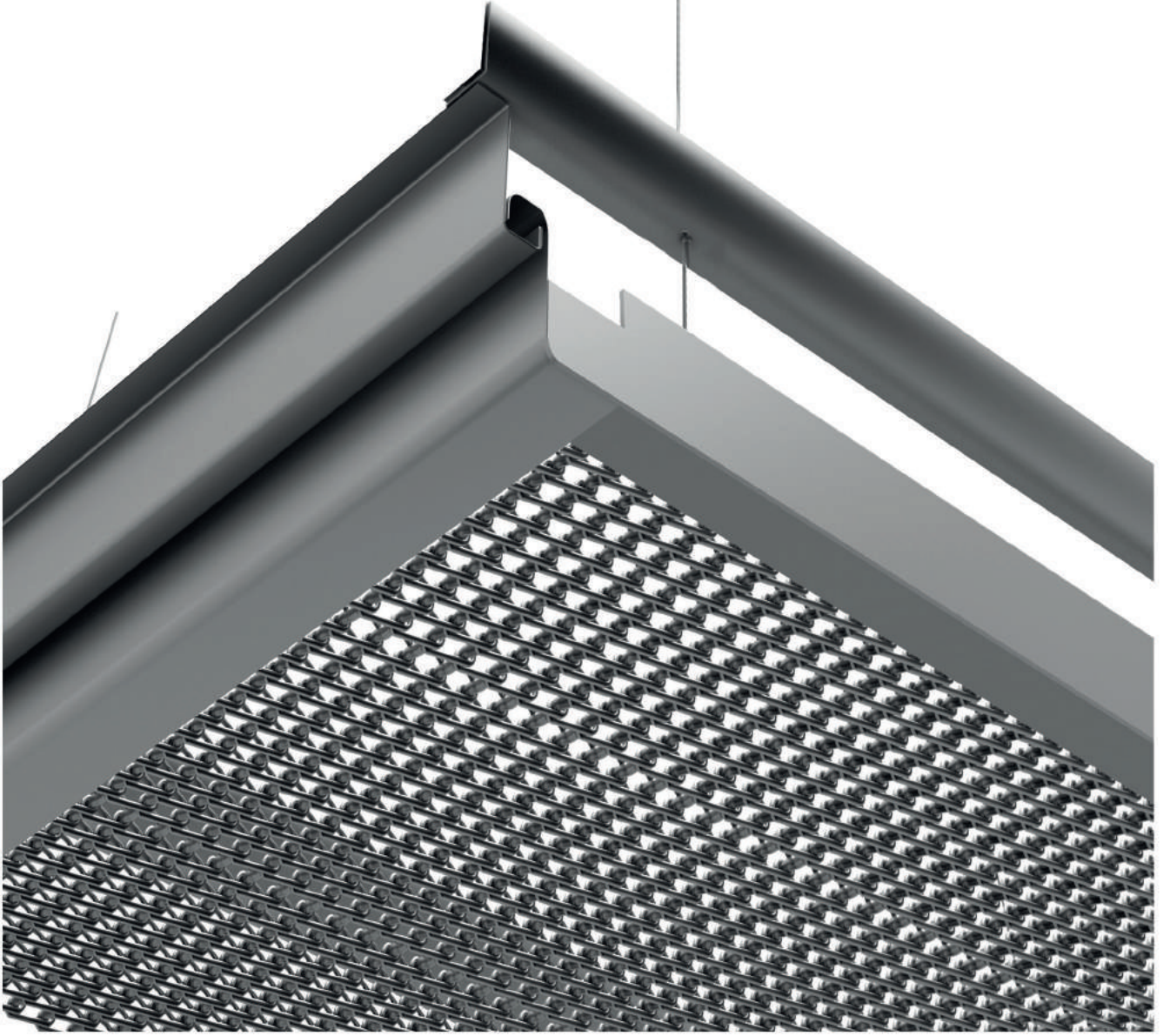

PANEL VIEW SCHEMA  
PANEL GÖRÜNÜM ŞEMASI

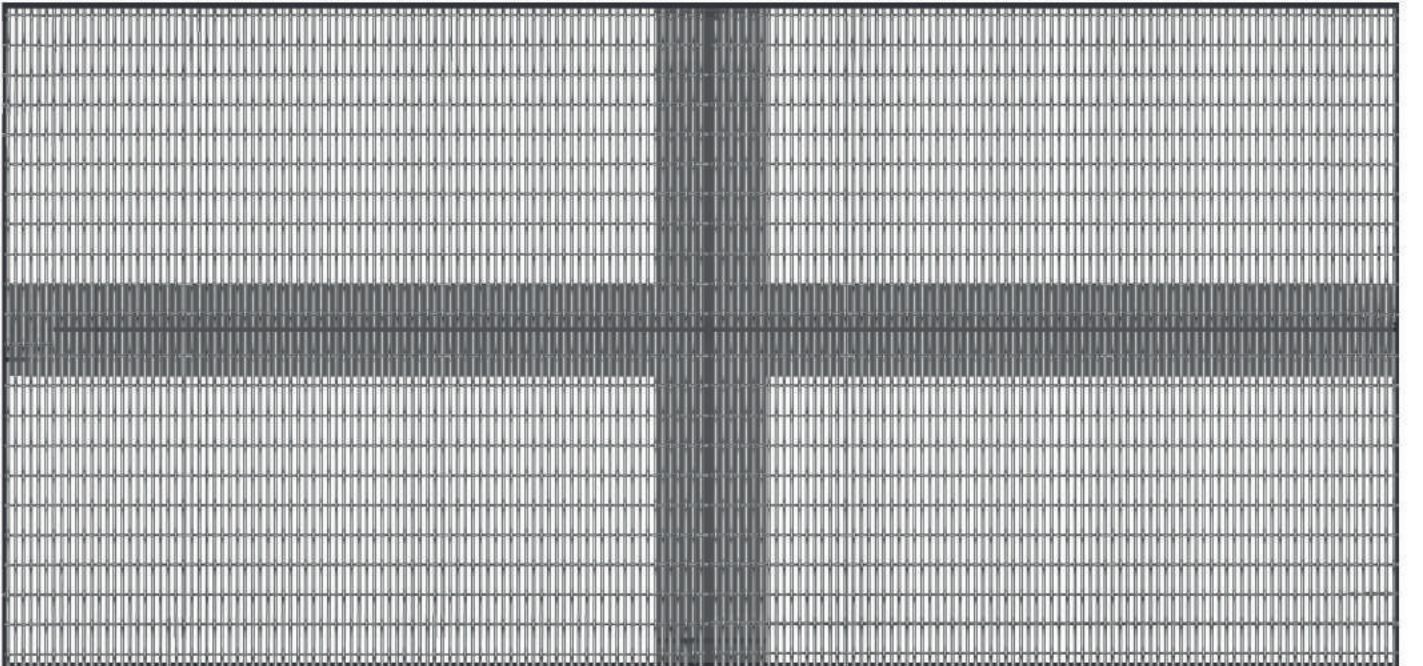

PANEL VIEW SCHEMA  
PANEL GÖRÜNÜM ŞEMASI

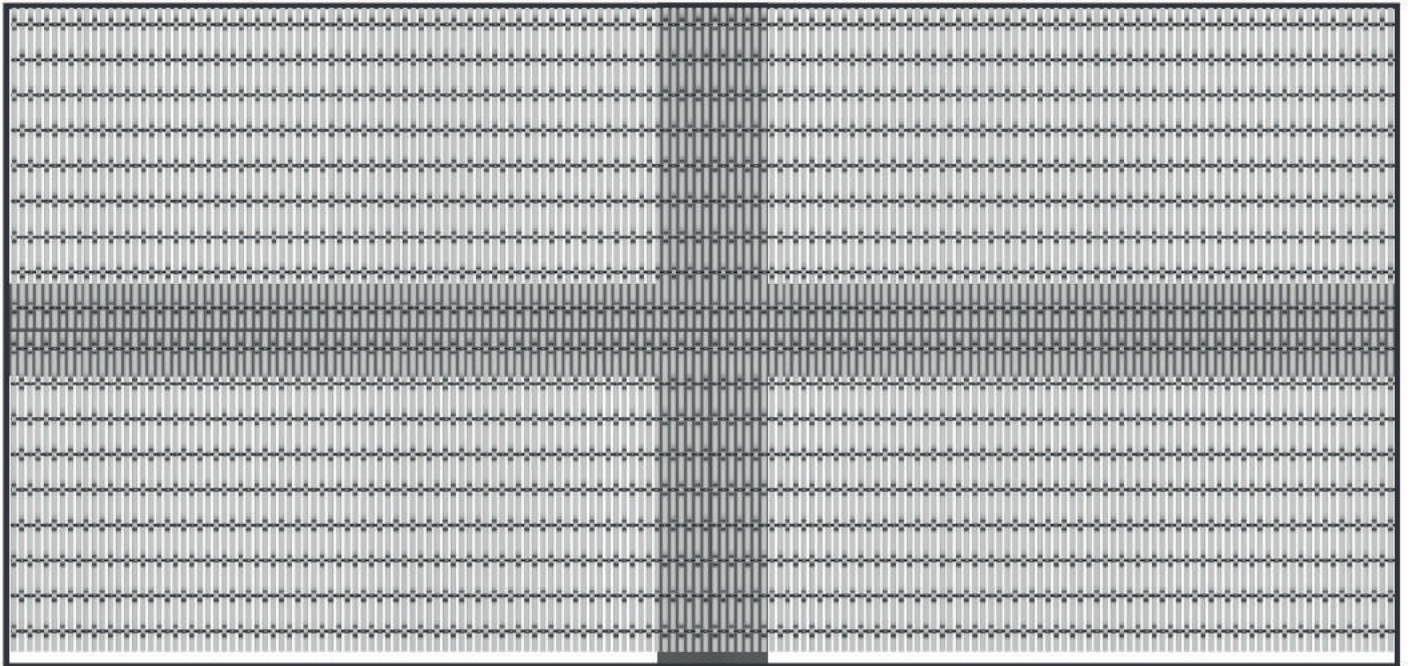
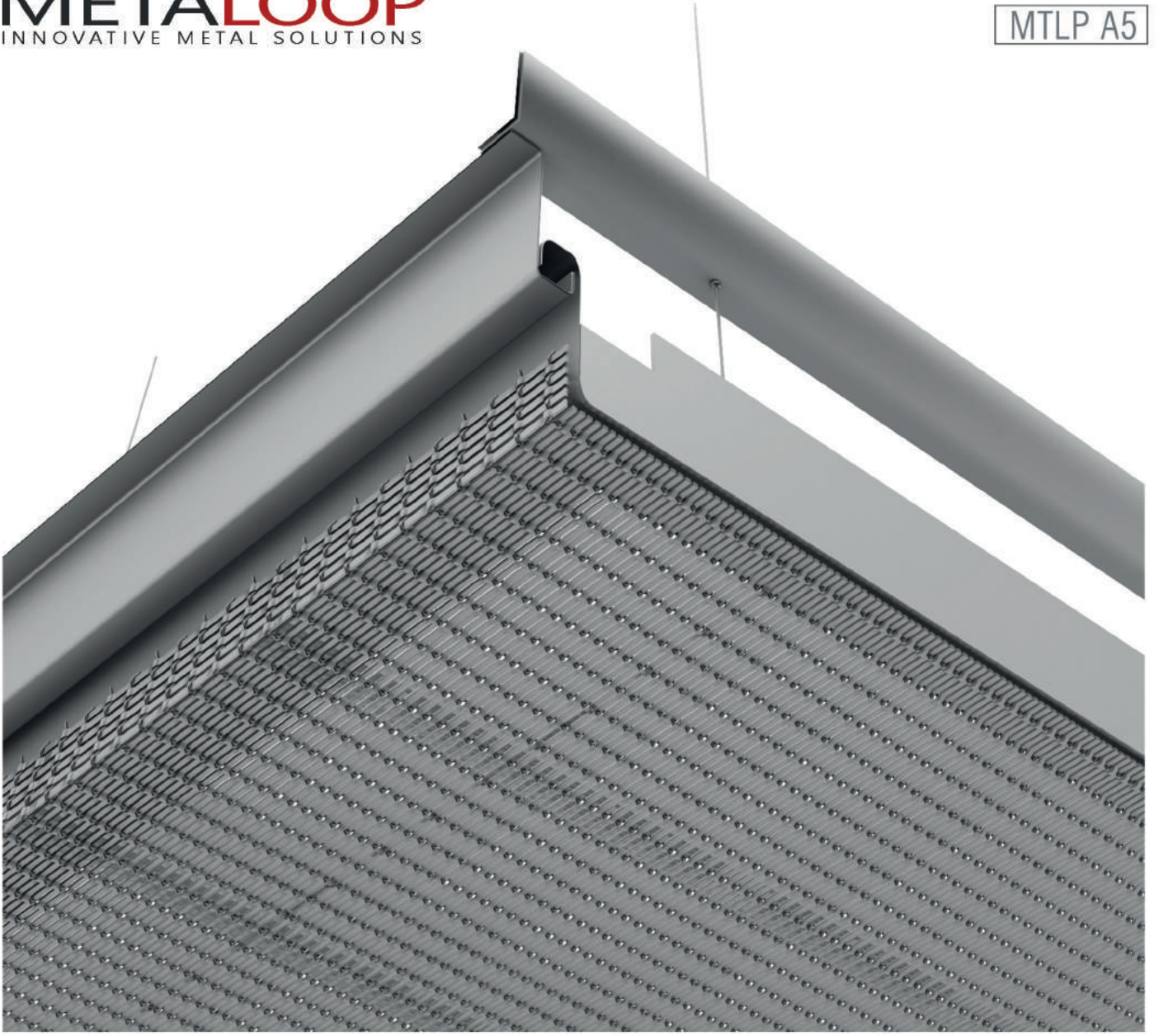

PANEL VIEW SCHEMA  
PANEL GÖRÜNÜM ŞEMASI

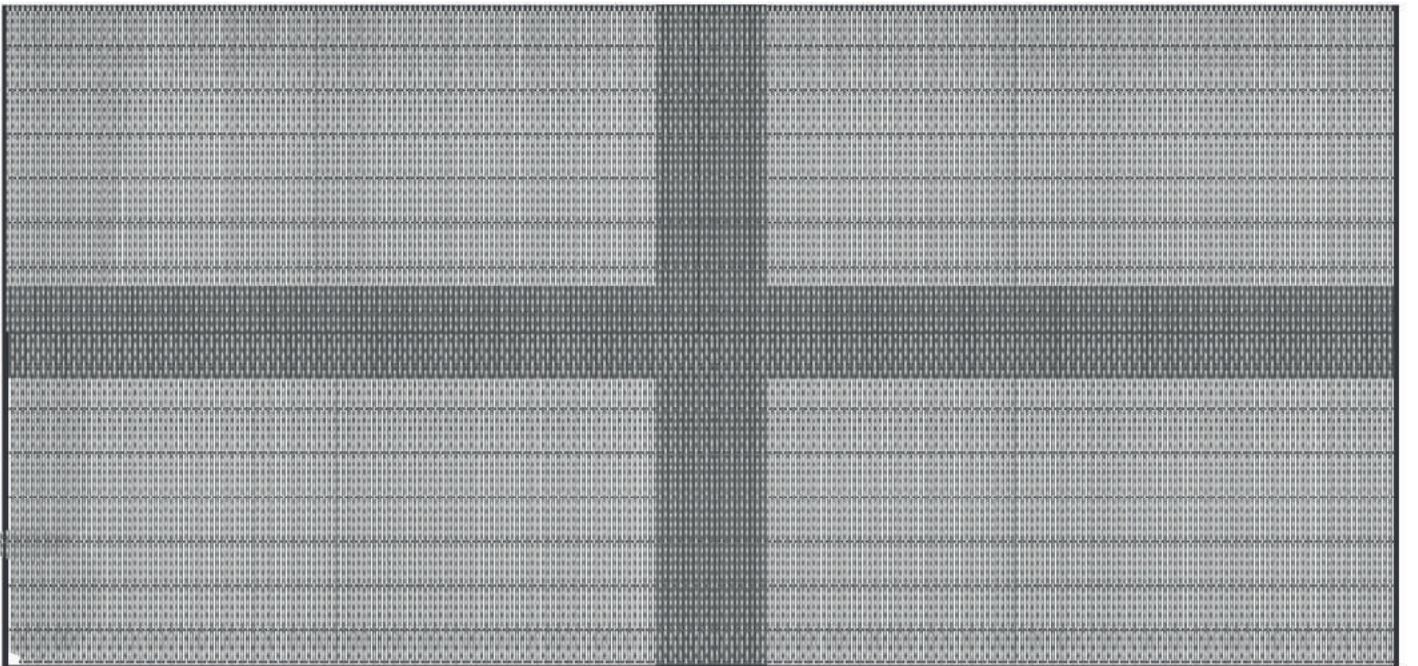
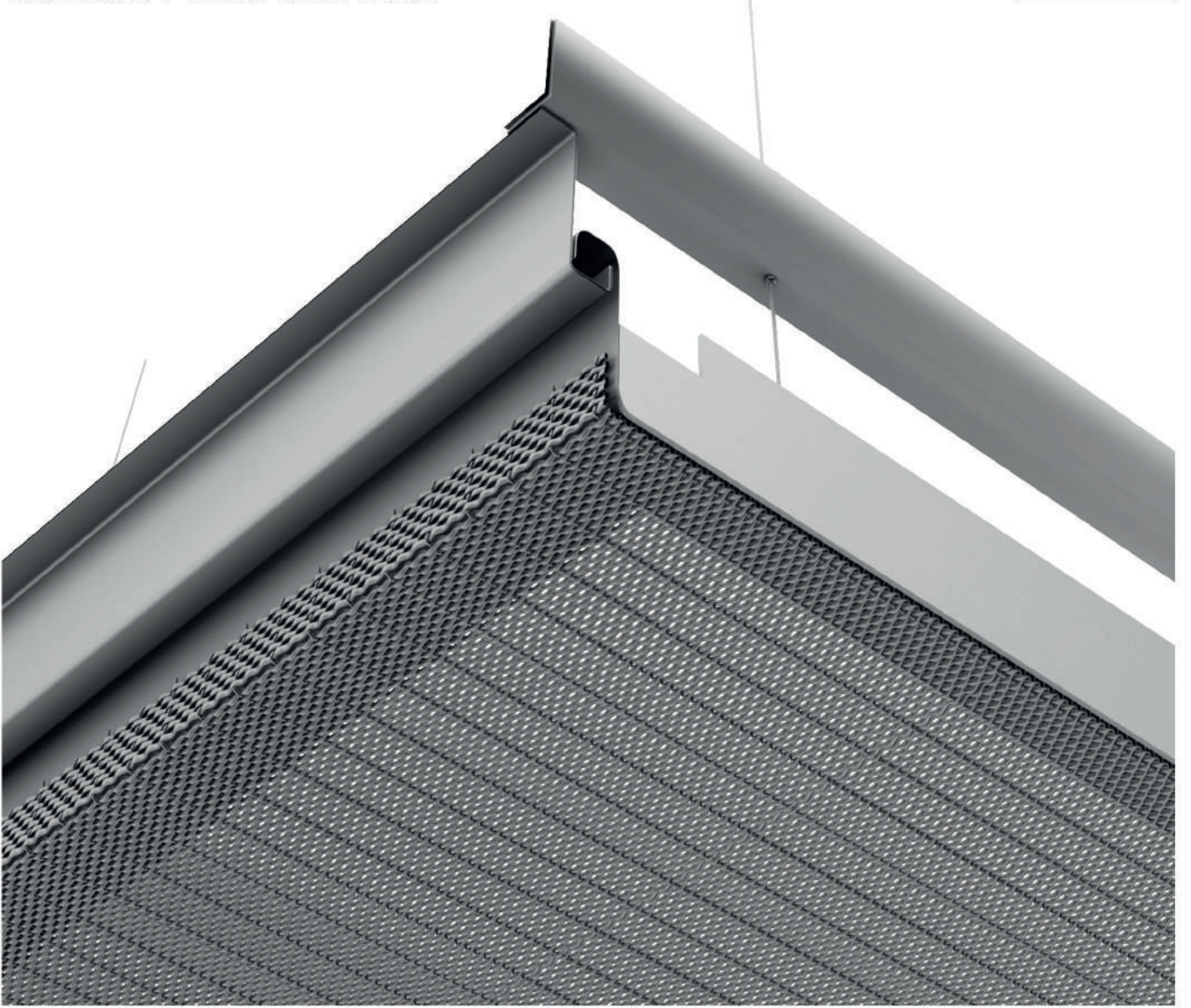

PANEL VIEW SCHEMA  
PANEL GÖRÜNÜM ŞEMASI

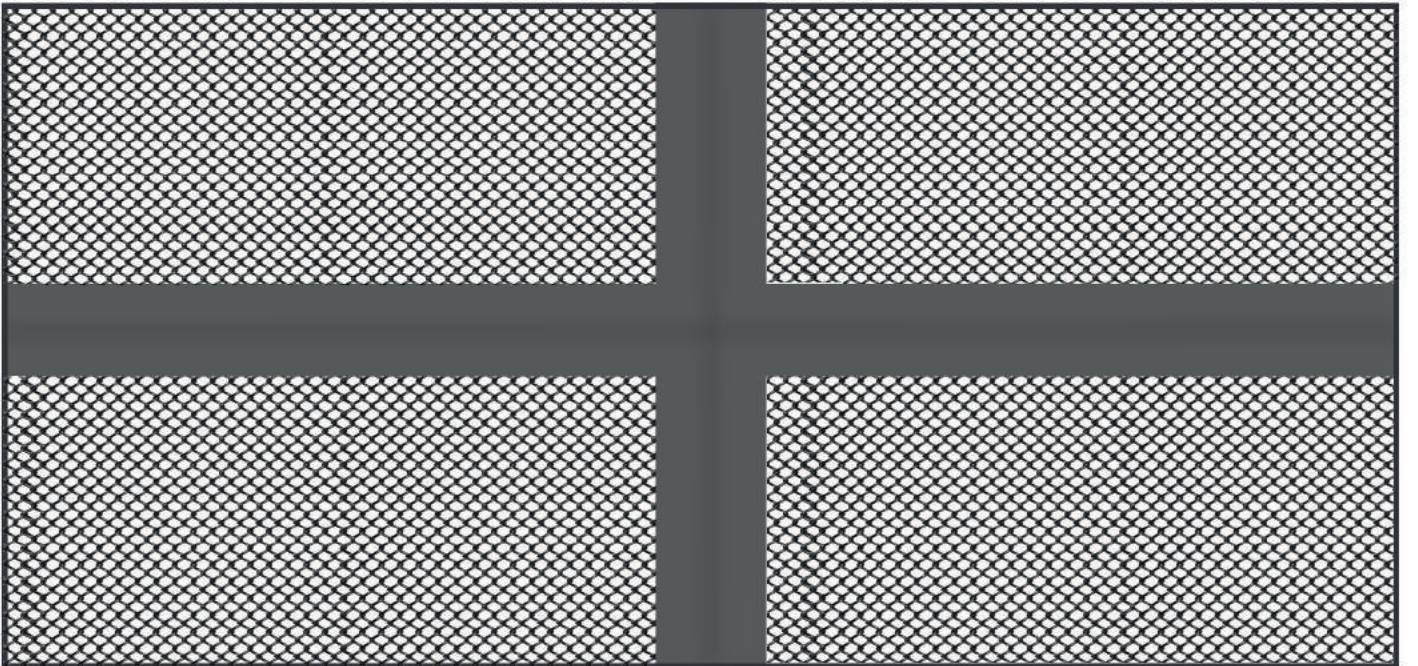
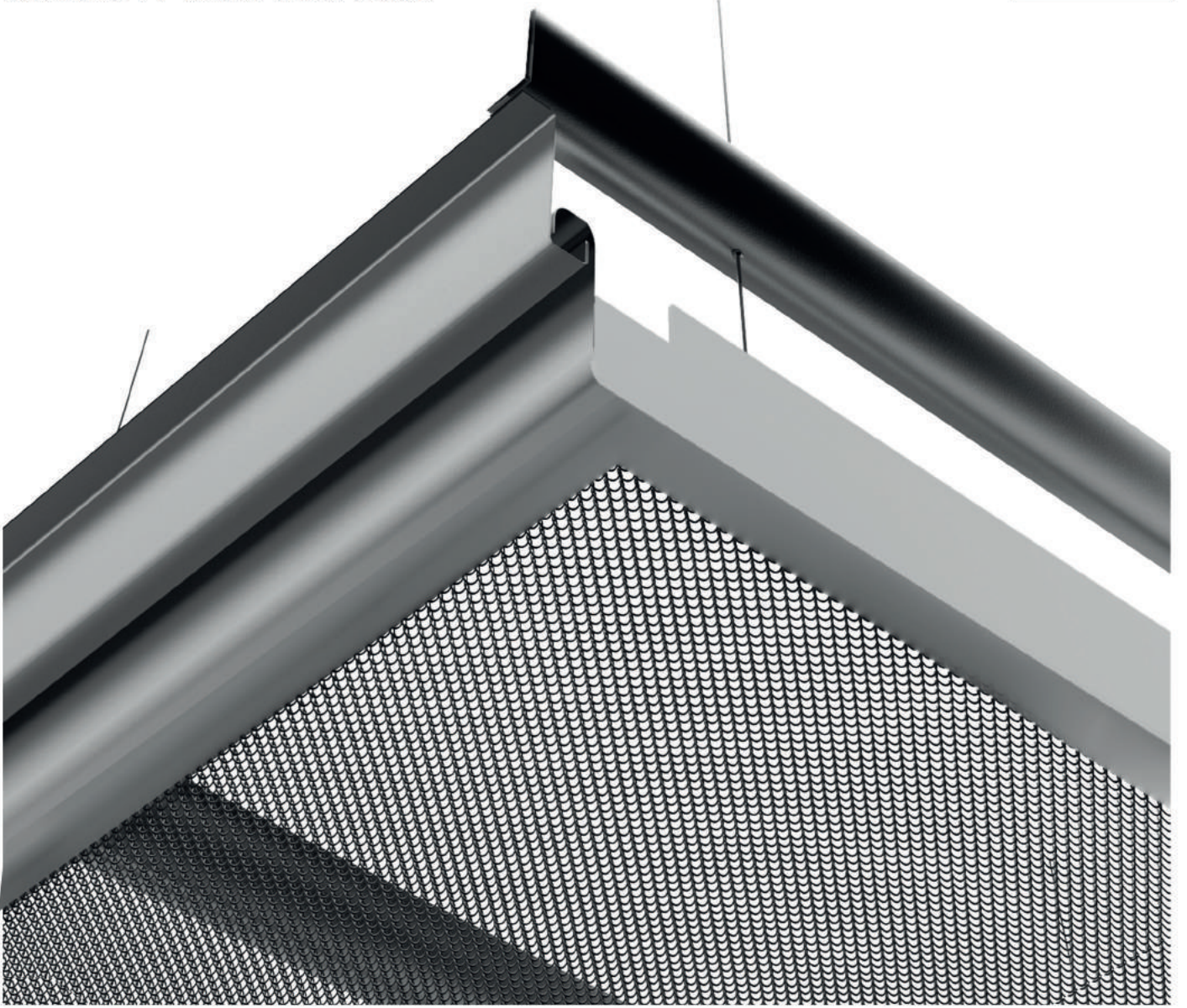

PANEL VIEW SCHEMA  
PANEL GÖRÜNÜM ŞEMASI

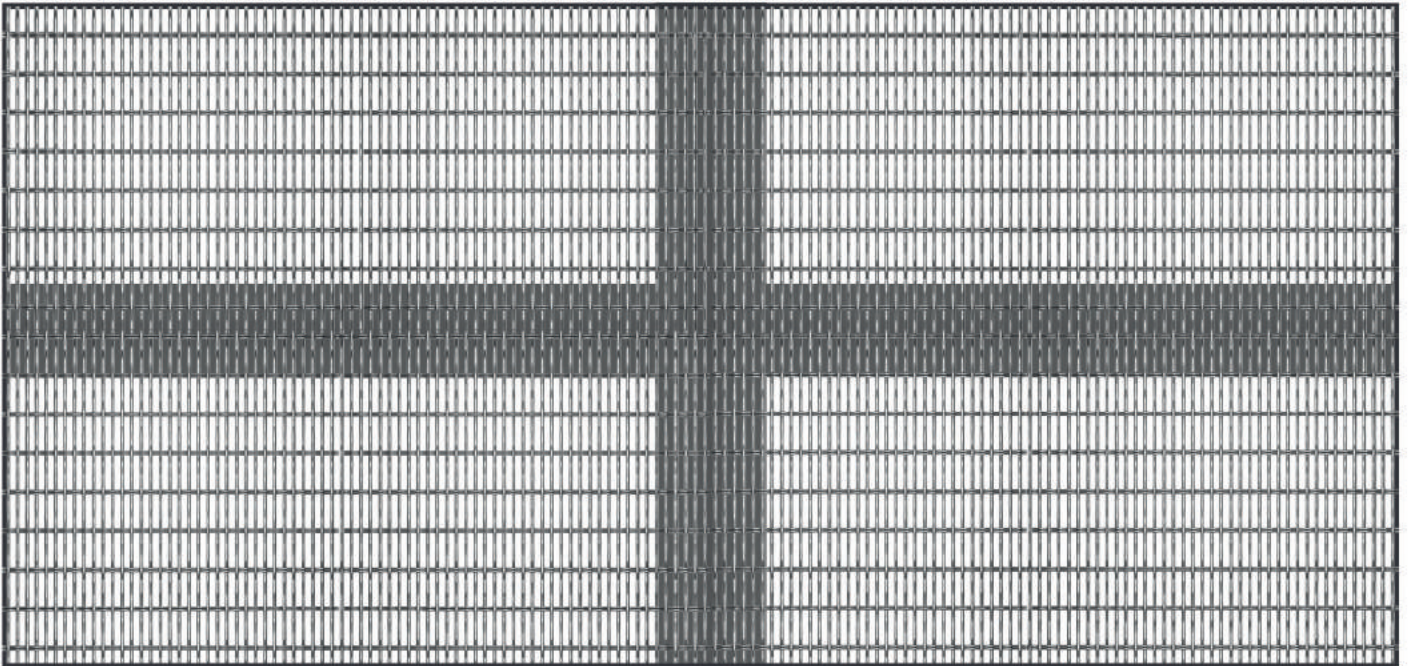
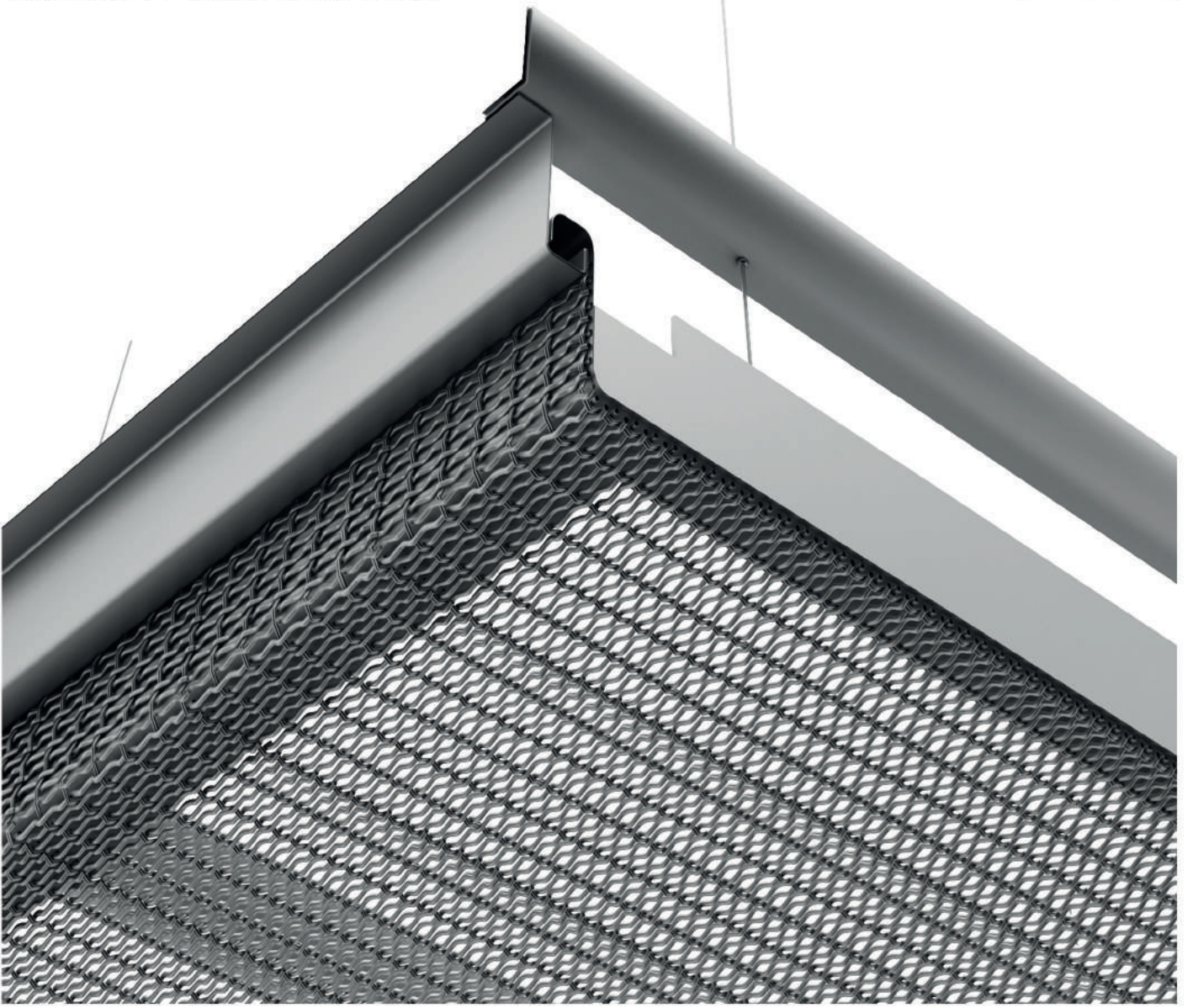

PANEL VIEW SCHEMA  
PANEL GÖRÜNÜM ŞEMASI

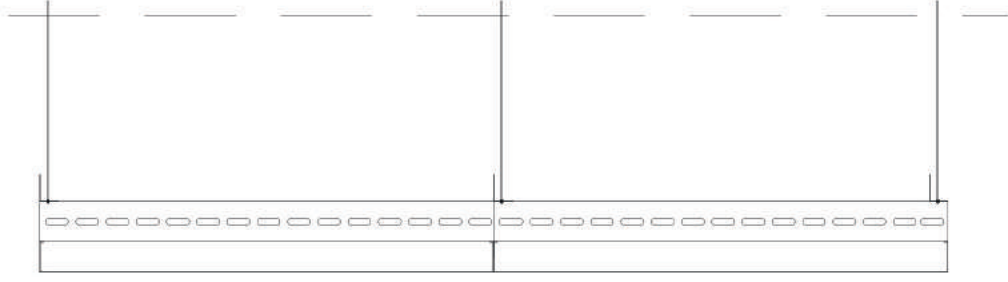

EN KESİT  
WIDTH SECTION  
ÖLÇEK/SCALE 1/10

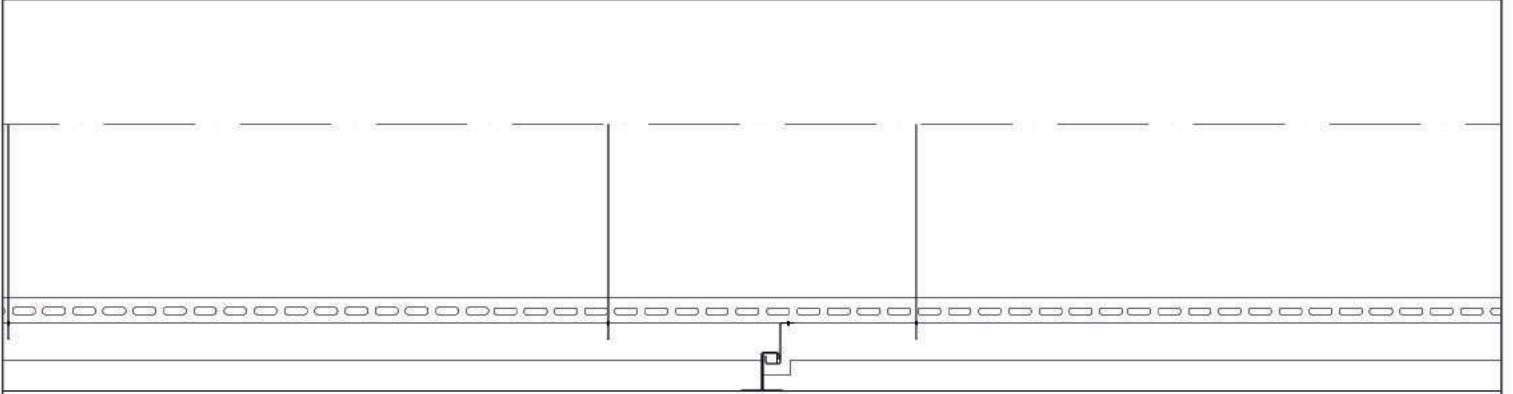

BOY KESİT  
LENGHT SECTION  
ÖLÇEK/SCALE 1/10

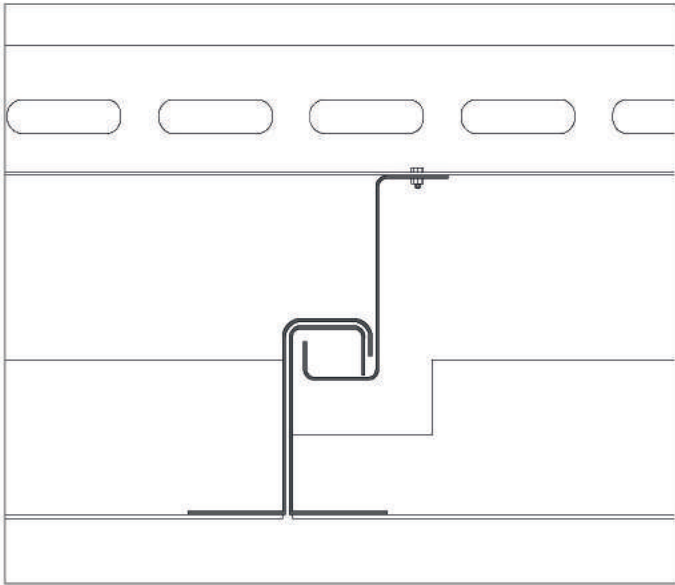

DETAY/DETAIL 1  
ÖLÇEK/SCALE 1/2

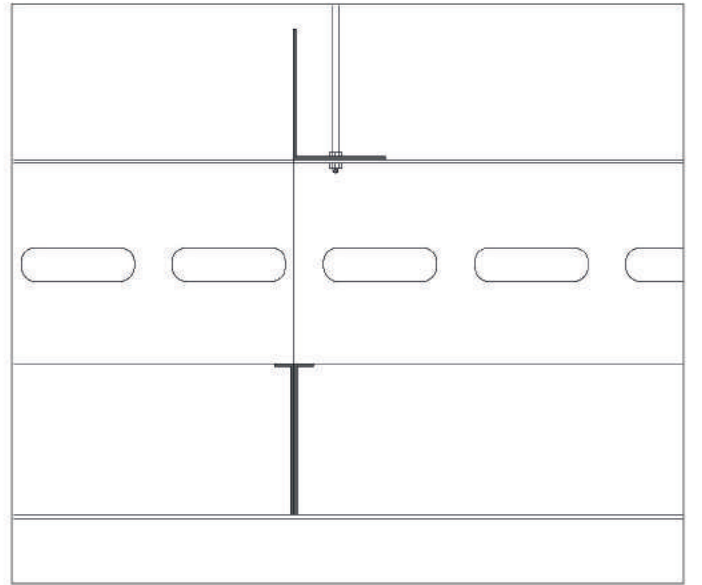

DETAY/DETAIL 2  
ÖLÇEK/SCALE 1/2

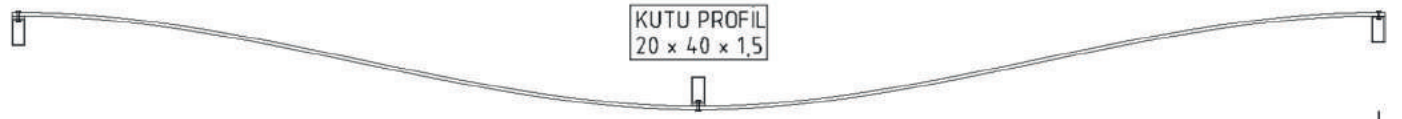

KUTU PROFIL  
20 x 40 x 1,5

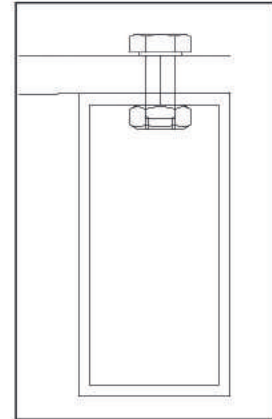

DETAY  
DETAIL

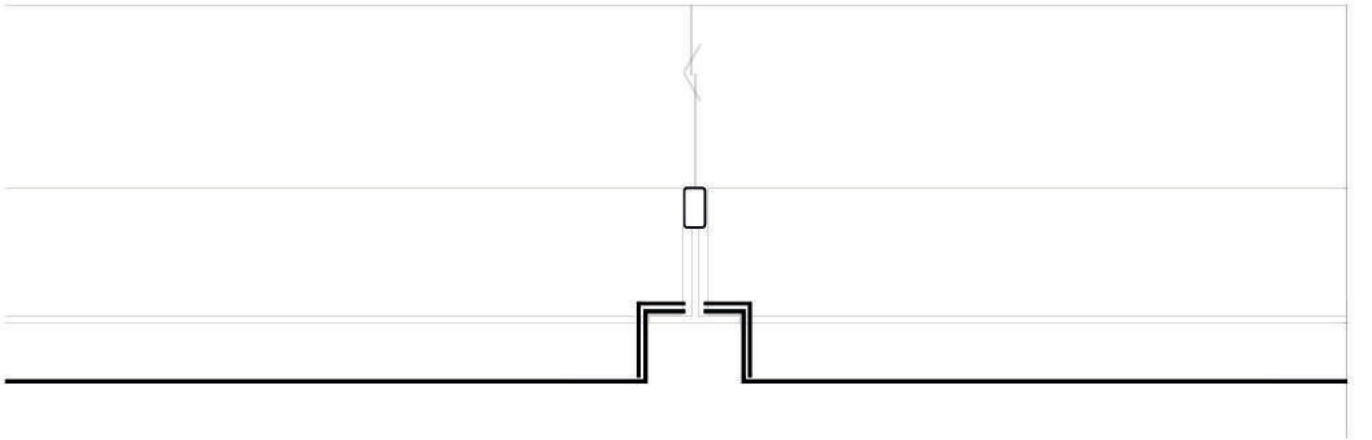

DETAY  
DETAIL

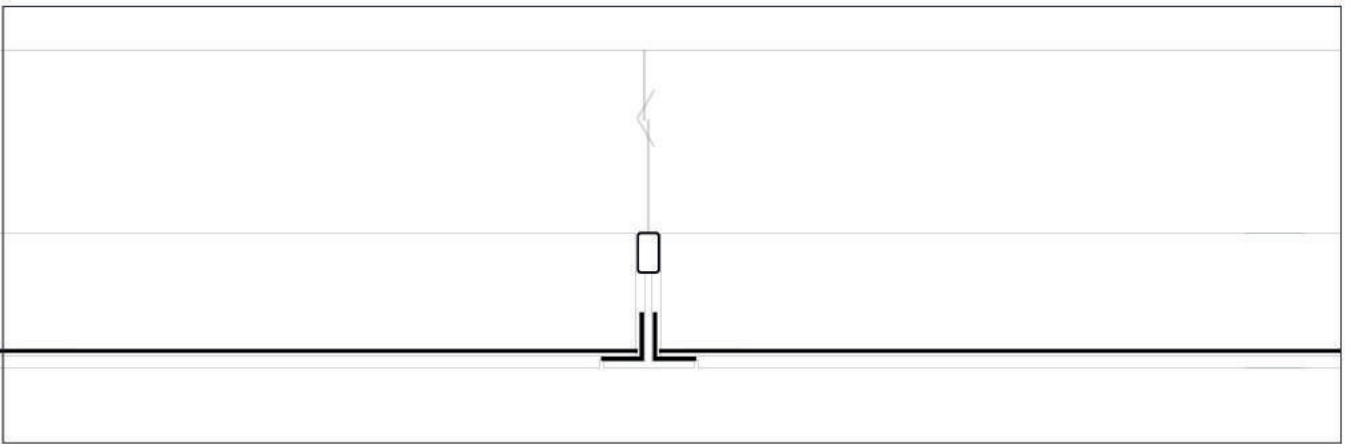

DETAY  
DETAIL

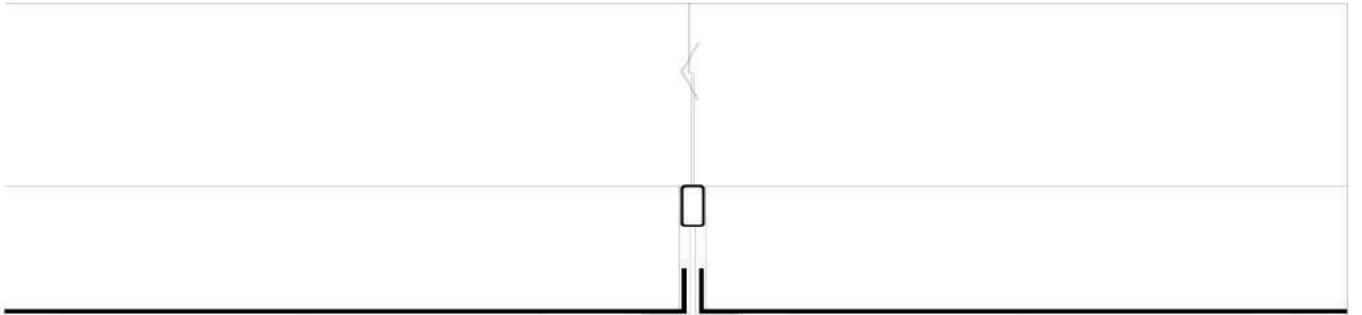

DETAY  
DETAIL

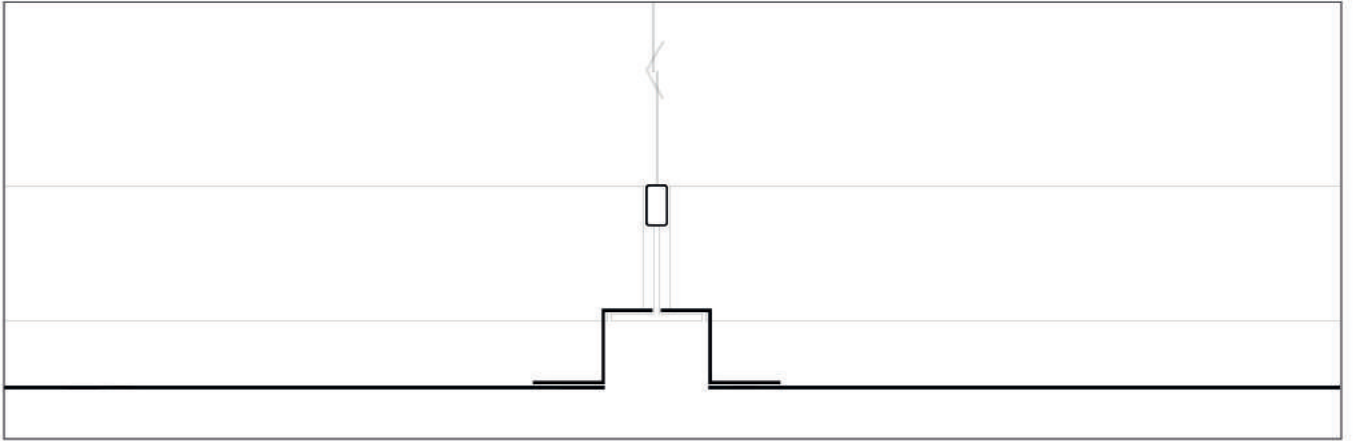
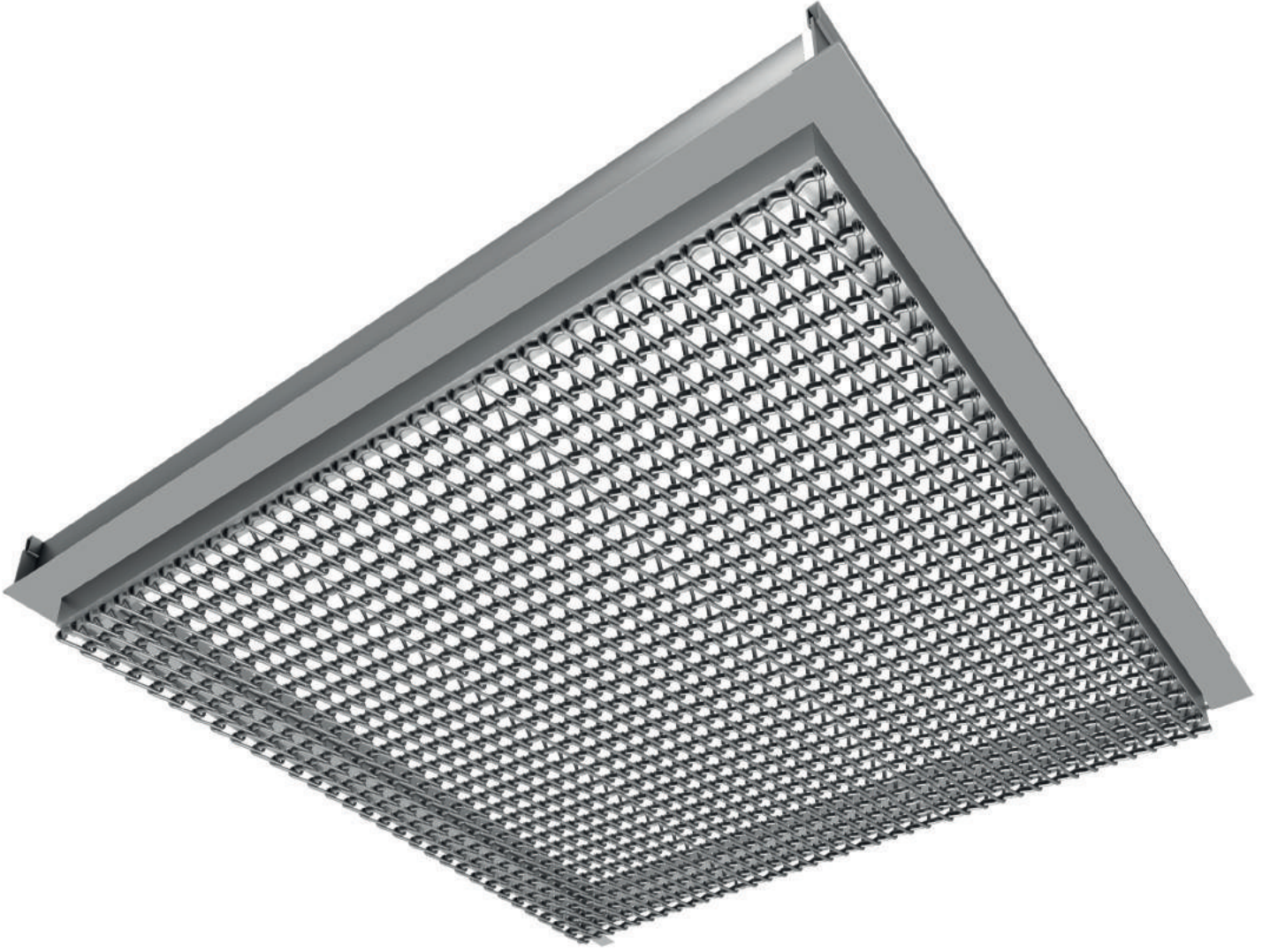

DETAY  
DETAY

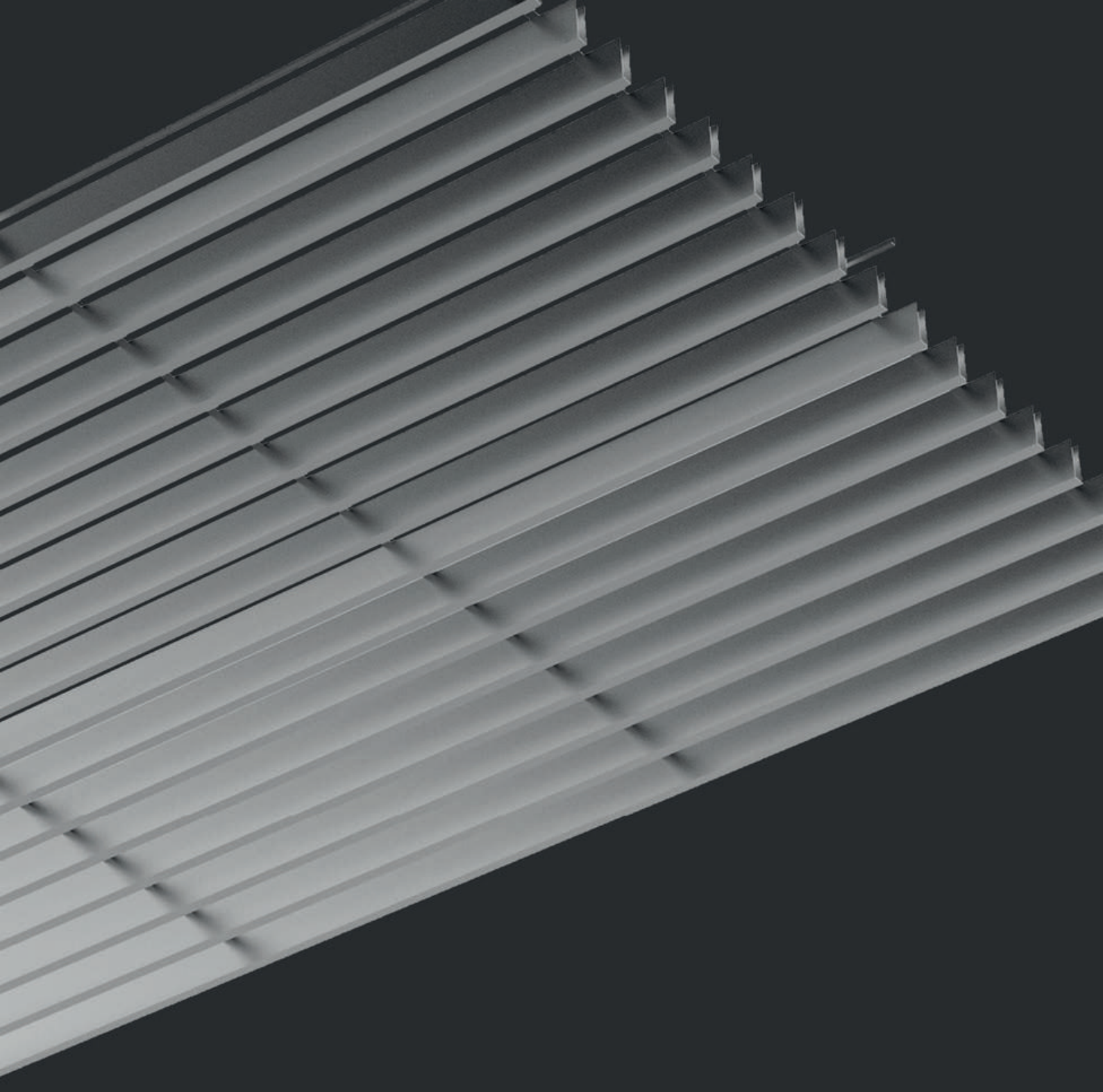

# BAFFLE ASMA TAVAN BAFFLE SUSPENDING CEILING

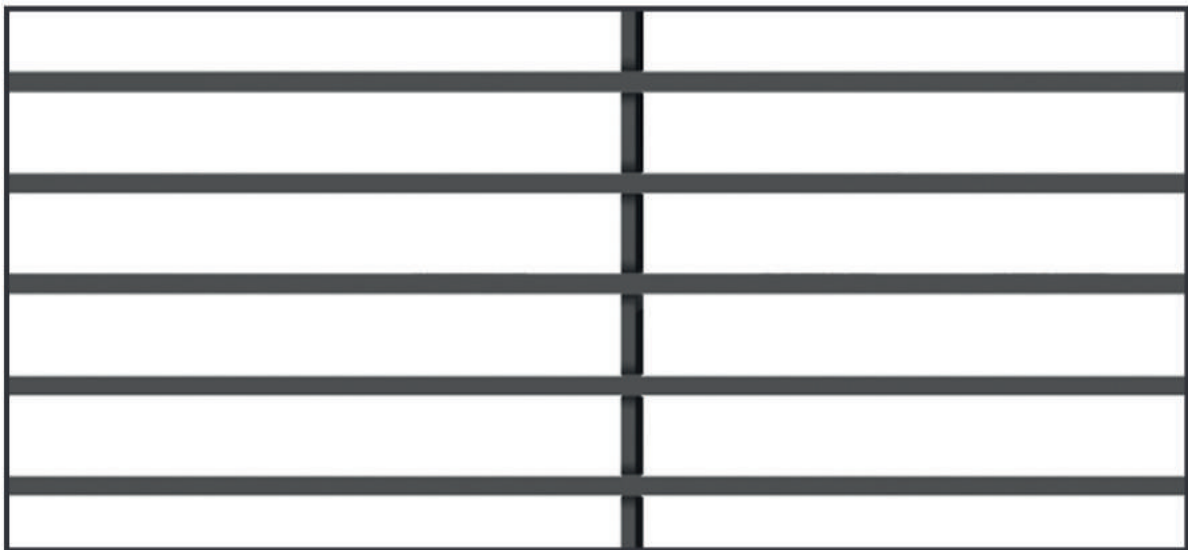
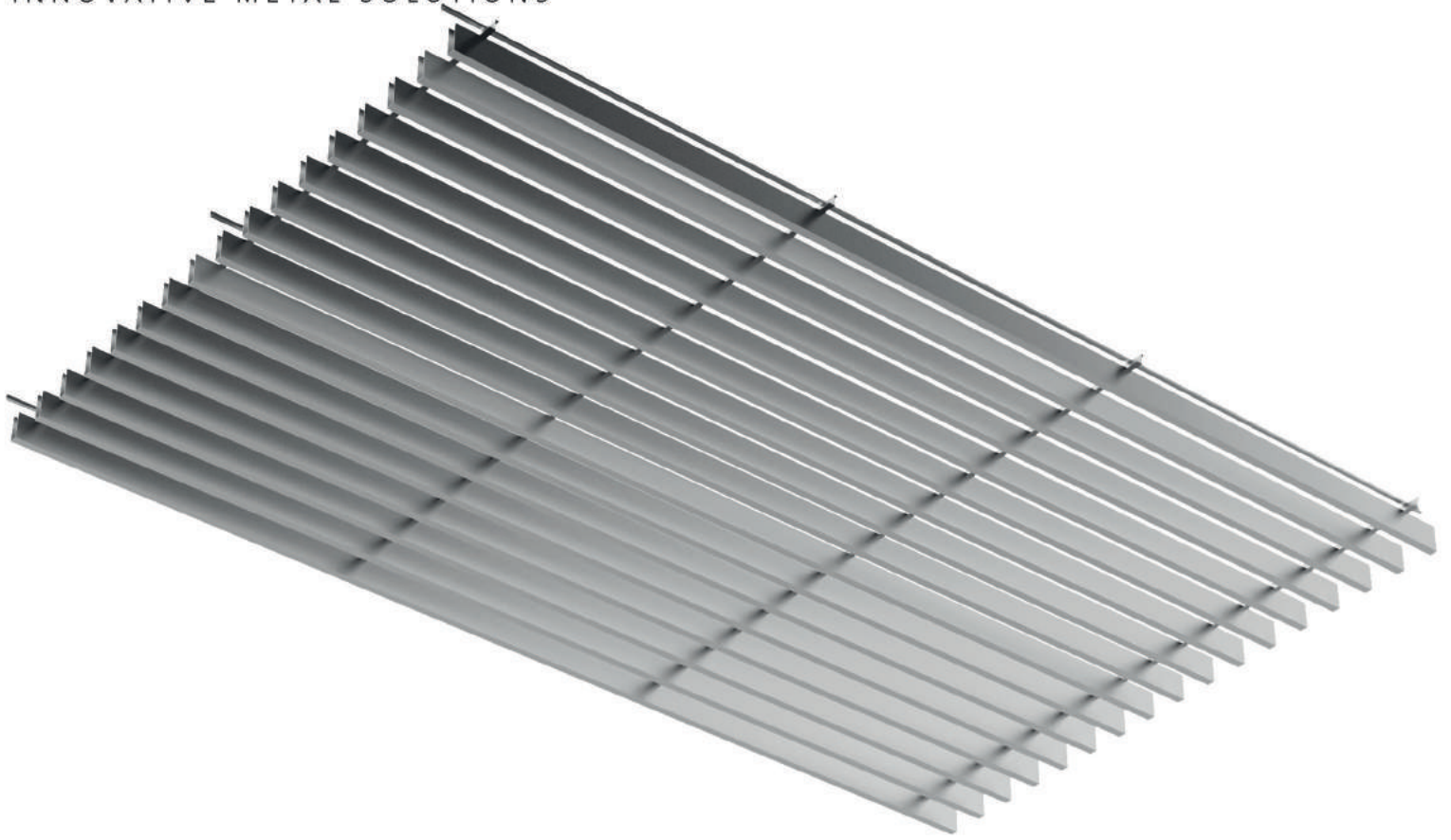

BOTTOM VIEW SCHEMA